

## MULTIPLE CONTROL CONNECTORS

Installazione pulita - Possono controllare più valvole contemporaneamente - Disponibili nelle forme A, B e C  
 Clean up installation - Can control many coils simultaneously - Available in form A, B and C  
 Schnelles Anschliessen zum Steuern von mehreren Ventilen - Lieferbar in Bauform A, B und C.

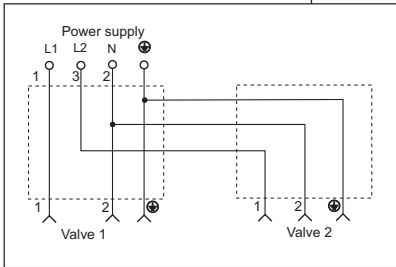

Per il codice d'ordine dei connettori multipli contattare l'ufficio vendite  
 For part No., please contact us  
 Für Bestellnr., bitte, kontaktieren Sie uns.

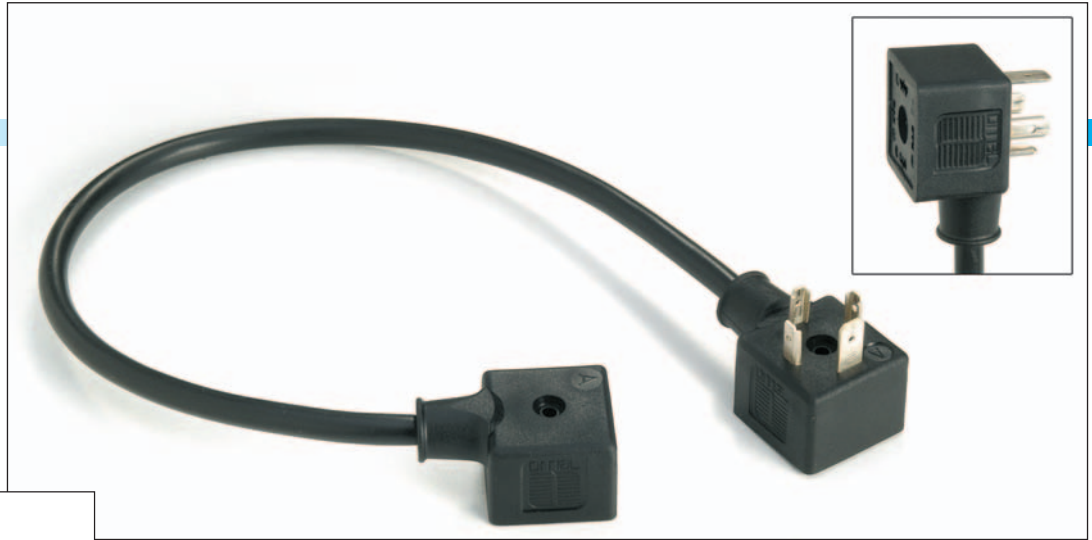
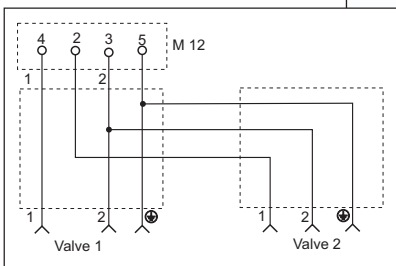
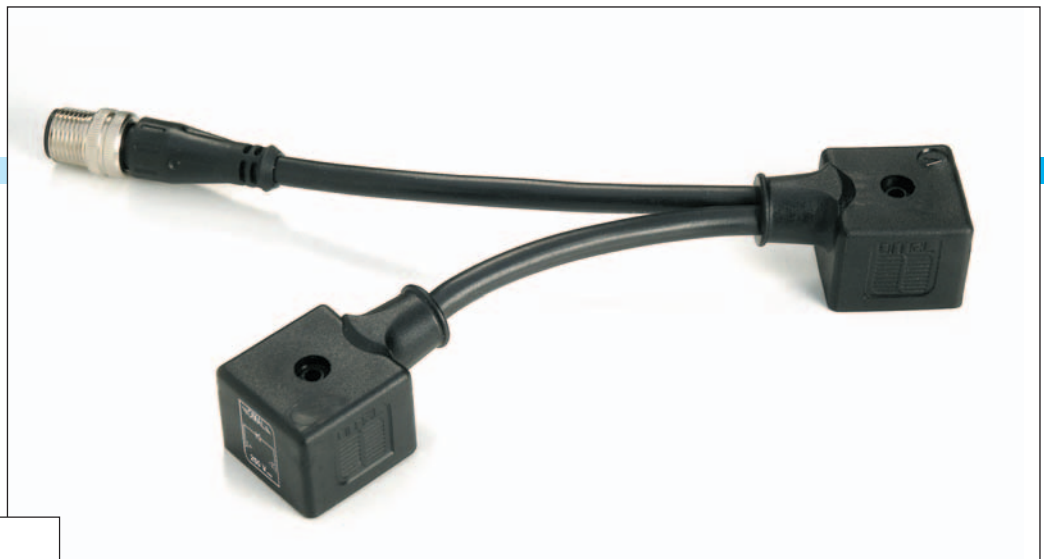

Per il codice d'ordine dei connettori multipli contattare l'ufficio vendite  
 For part No., please contact us  
 Für Bestellnr., bitte, kontaktieren Sie uns.

## MULTIPLE CONTROL CONNECTORS

Disponibili nelle forme A, B e C - Con o senza terminazione M8 - M12

Available in form A, B and C and with/without round connectors M8 - M12

Lieferbar in Bauform A, B und C mit/ohne M8 - M12

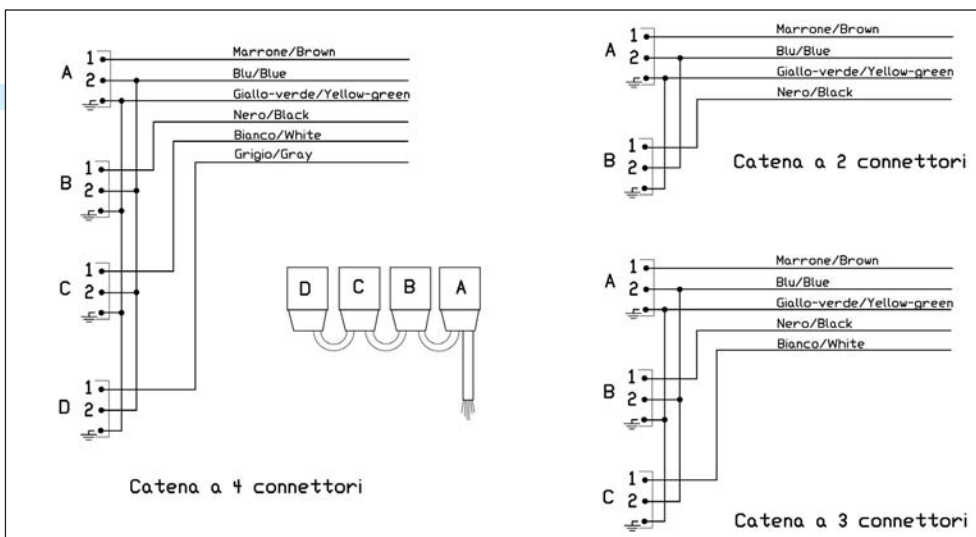
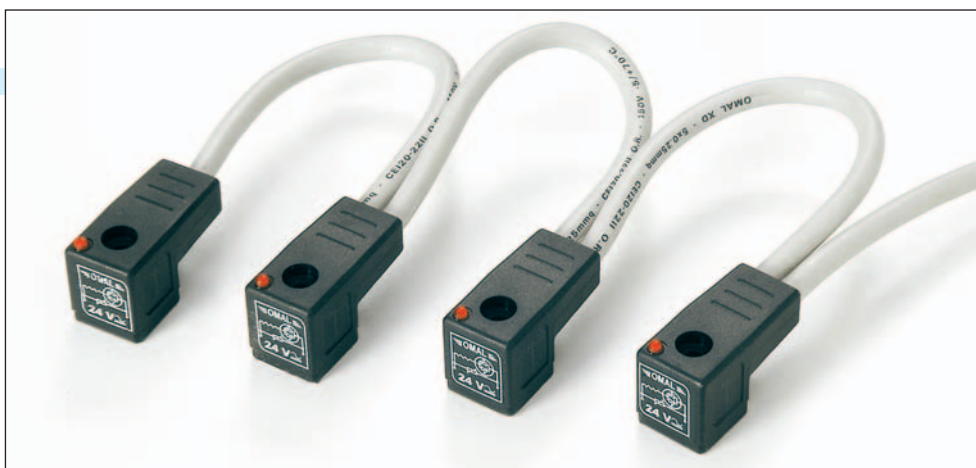

Disponibili con 2 - 3 - 4 connettori forma A - B - C con connessioni indipendenti o in parallelo

Per il codice d'ordine dei connettori illustrati in queste pagine contattare l'ufficio vendite

For part No., please contact us

Für Bestellnr., bitte, kontaktieren Sie uns.

# CONNECTION BOX

- Box di connessione
- *Distribution Box*
- *Miniaturo-Box*

BOX

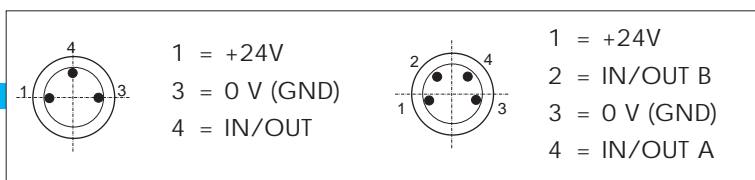

- Box con 4, 6 o 8 punti di connessione attacchi M8 disponibili in versione a 3 o 4 poli
- LED di segnalazione giallo sulle uscite e LED verde di presenza alimentazione
- Disponibili con cavo di uscita fisso dritto oppure a 90°

- *Miniature connection box, 4 - 6 - 8 ways, 3 and 4 poles, M8 connector*
- *LED: power supply green, function indicator yellow*
- *Available with straight and 90° cable entry*

- *Miniaturo-Box, 4 - 6 - 8 fach, 3 - 4 polig, M8 Buchse*
- *LED: Betriebsanzeige grün, Funktionsanzeige gelb*
- *Lieferbar mit geradem bzw. 90° Kabelanschluss*



# CONNECTION BOX

- Box di connessione
- *Distribution Box*
- *Miniatür-Box*



- Ogni singola posizione può essere personalizzata secondo le più diverse esigenze di connessione con combinazioni di connettori DIN, M8 e M12 e cavo nelle lunghezze desiderate.



- *Each output can be fitted up with any DIN, M8 and M12 connector and any cable length.*
- *Jede Position kann mit verschiedenen DIN-, M8-, and M12-Steckern und beliebiger Kabellänge verkabelt werden.*

# PRODOTTI CUSTOM

- Customized products



# E.O.C.

---

Electronic Opto Components  
M.Büchner GmbH & CoKG

Heegwaldring 2  
63694 Limeshain

Telefon: +49(0)6047 - 96 28-0  
Telefax: +49(0)6047 - 96 28-14

E-Mail: [info@m-buechner.de](mailto:info@m-buechner.de)  
Internet: [www.m-buechner.de](http://www.m-buechner.de)